

LINEA-IN20 TRIMLESS EF

RECESSED PROFILE / PROFIL WPUSTOWY

max 20 mm

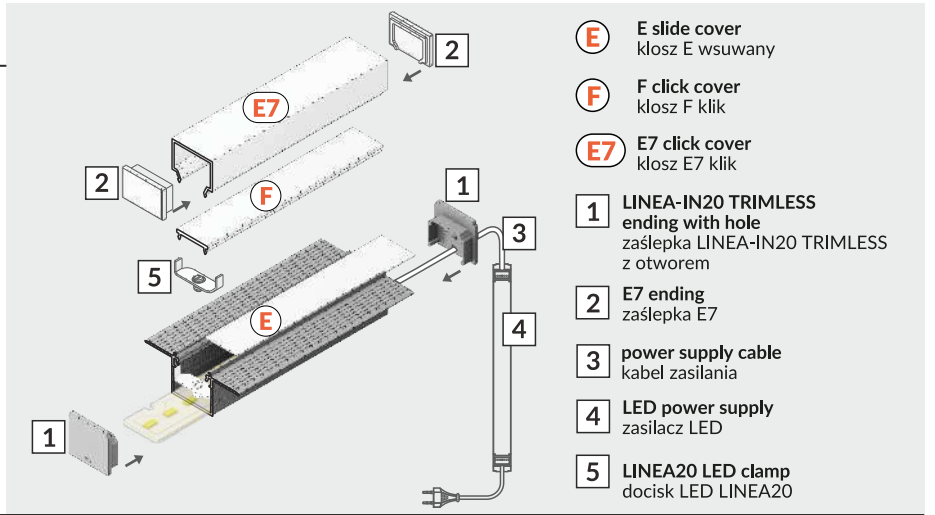
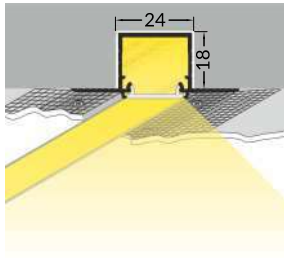
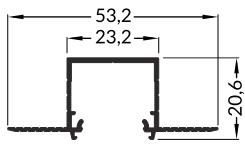

- E** E slide cover
klosz E wsuwany
- F** F click cover
klosz F klik
- E7** E7 click cover
klosz E7 klik
- 1** LINEA-IN20 TRIMLESS
ending with hole
zaślepka LINEA-IN20 TRIMLESS
z otworem
- 2** E7 ending
zaślepka E7
- 3** power supply cable
kabel zasilania
- 4** LED power supply
zasilacz LED
- 5** LINEA20 LED clamp
docisk LED LINEA20

- scissors
nożyczki
- hacksaw
piłka
- screwdriver
wkrętak
- glue
klej
- drill
wiertarka
- spatula
szpachelka

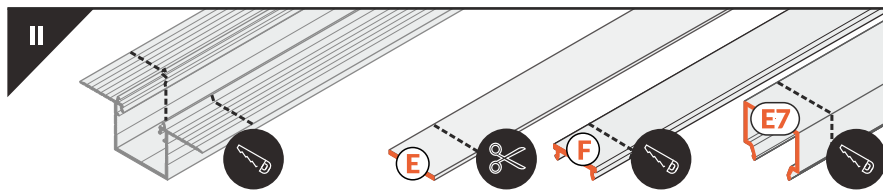
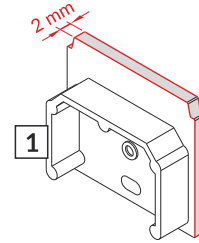
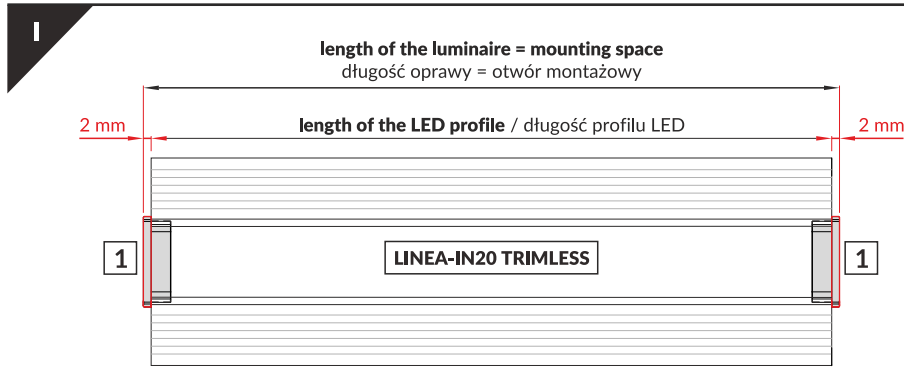

The length of the cover is equal to the length of the profile. / Długość klosza równa jest długości profilu.

III RECOMMENDED LED MODULE: / REKOMENDOWANY MODUŁ LED: PHILIPS Fortimo LED strip LV

double-sided thermally
conductive tape 15mm x 50m
taśma termoprzewodząca
dwustronna 15mm x 50m

LINEA20 LED clamp
docisk LED LINEA20

x 6 / 1 m

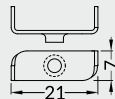

LINEA20-1 LED clamp + LINEA20 LED mounting
docisk LED LINEA20-1 + mocowanie LED LINEA20

x 6 / 1 m

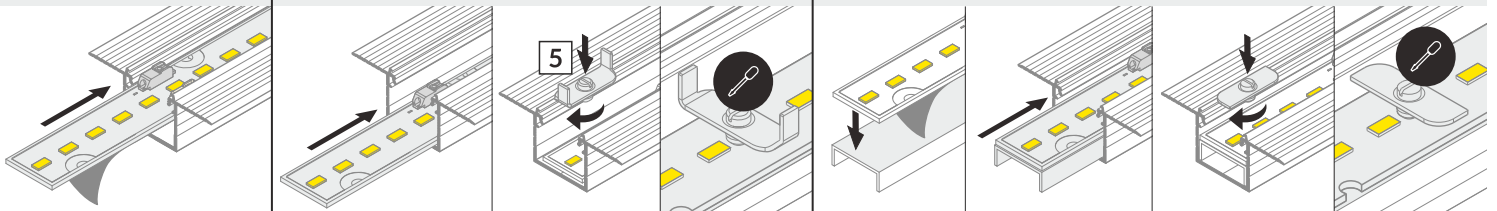
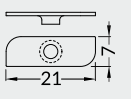

Dimensions of the space to install LED source.
Wymiary przestrzeni do zamontowania źródła LED.

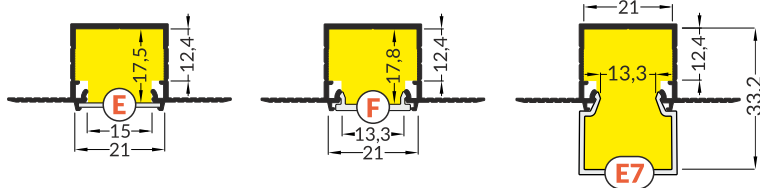

Dimensions of the space to install LED source.
Wymiary przestrzeni do zamontowania źródła LED.

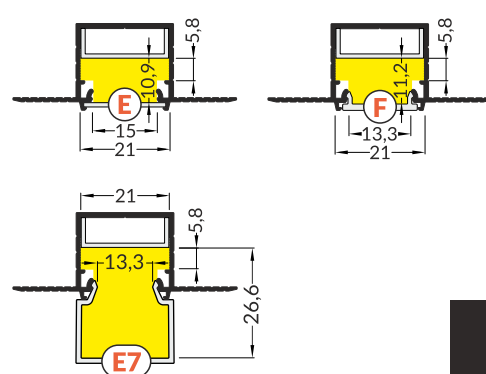

IV POWER SUPPLY - secondary side / ZASILANIE - strona wtórna

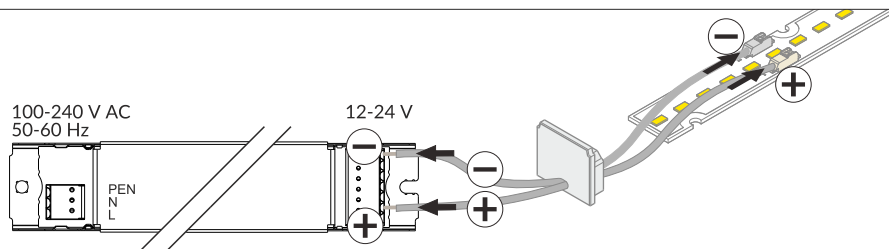

V E slide cover / kłozs E wsuwany

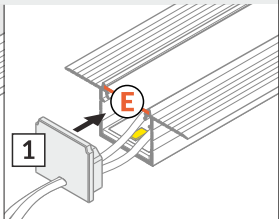
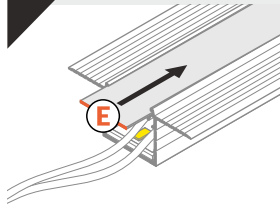

F click cover / kłozs F klik

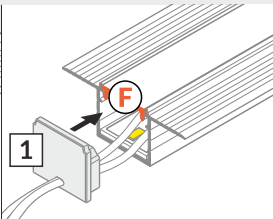
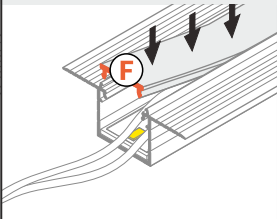

E7 click cover + E7 ending / kłozs E7 klik + zaślepka E7

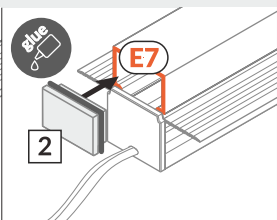
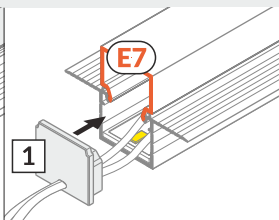
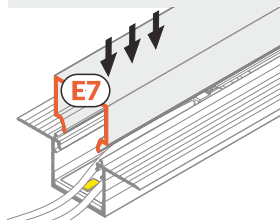

VI MOUNTING / MONTAŻ

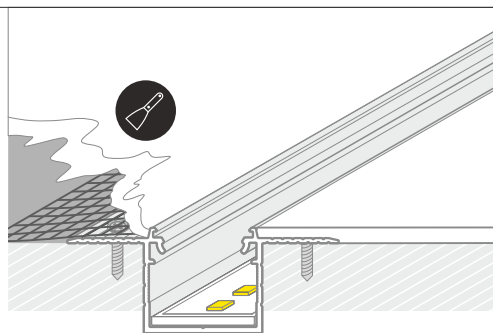
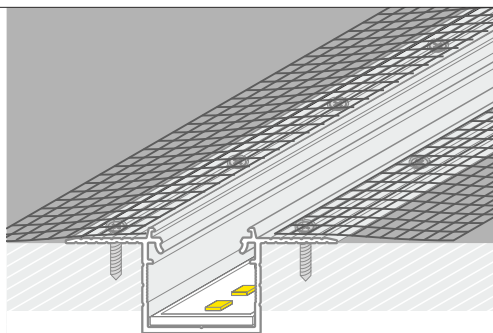
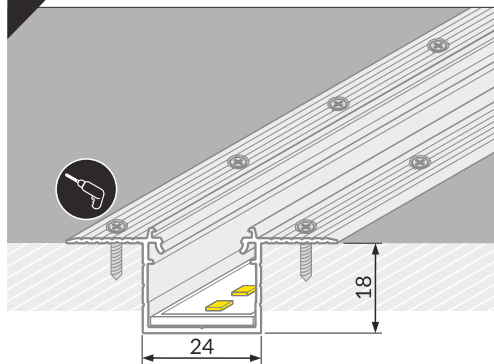

VII POWER SUPPLY - primary side / ZASILANIE - strona pierwotna

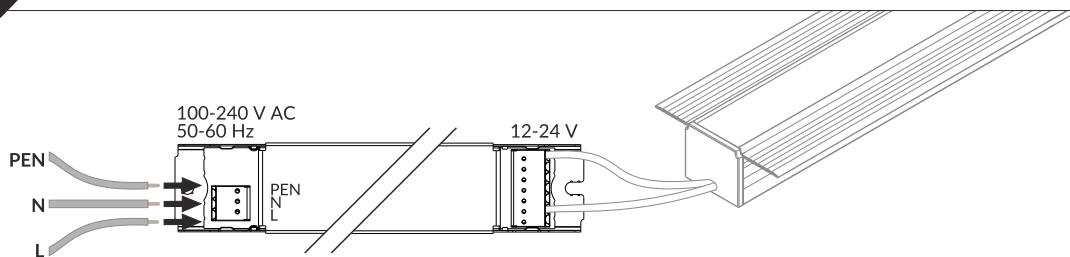

ACCESSORIES / AKCESORIA

power switches / włączniki
 controller + remote / sterownik + pilot
 movement sensors / czujniki ruchu